

Systeme für Aquakultur,
Aquaristik, Labore und
zur Wasseraufbereitung

Systems for aqua culture,
sea water aquaria, labs and
water desalination and purification

Systèmes pour aquaculture,
aquariums eau de mer,
laboratoires et traitements d'eau



AquaCare GmbH & Co. KG
Am Wiesenbusch 11
D-45966 Gladbeck
Tel.: +49-2043-375758-0
Fax: +49-2043-375758-90
<http://www.aquacare.de>
e-mail: info@aquacare.de

Leerfilter 150 / Empty Filter 150 Leerreaktor 150 / Empty Reactor 150



Filter 150

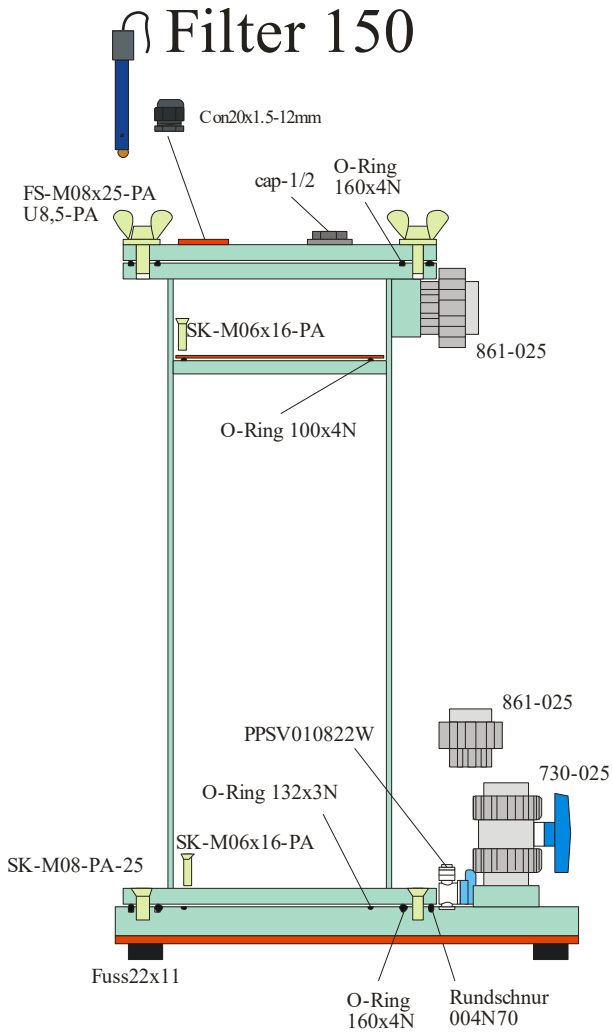

Reactor 150

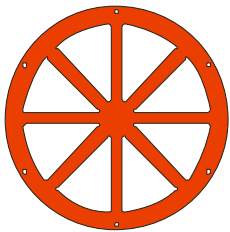
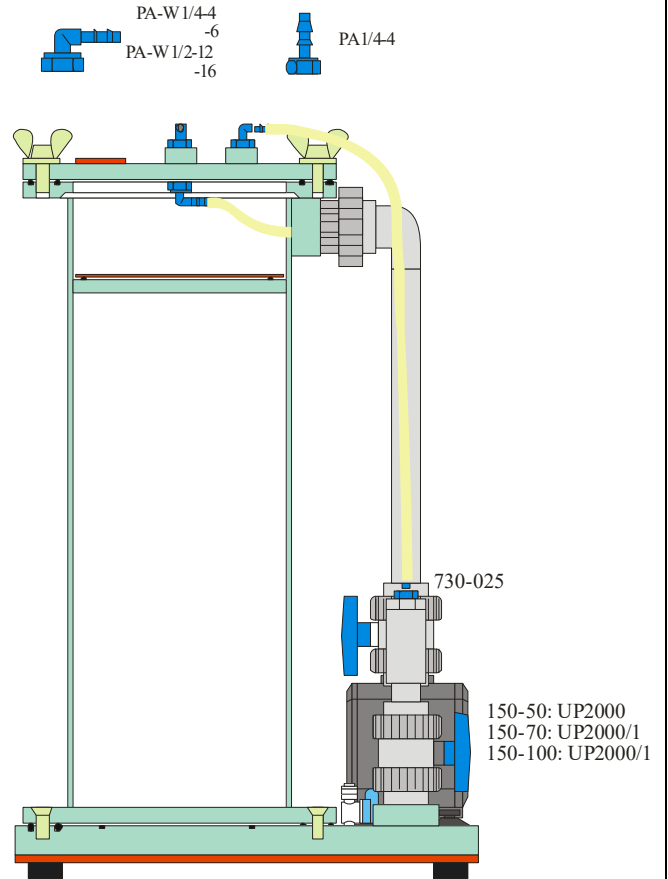

MF2-150-6µm
 MF2-150-15µm
 MF2-150-25µm
 MF2-150-50µm
 MF2-150-100µm
 MF2-150-150µm
 MF2-150-200µm
 MF2-150-2mm

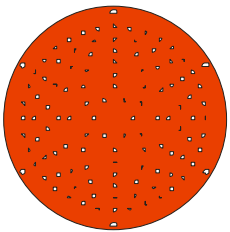

MF2-150-4mm
 MF2-150-8mm

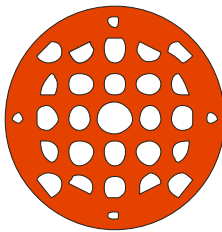

MF2-150-15mm
 MF2-150-15mm+

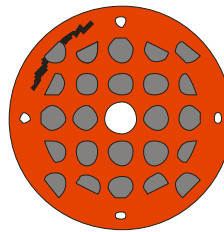

MF2-150-ADN

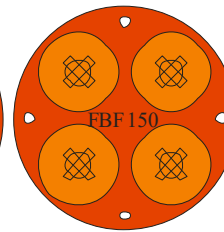

MF2-150-FBF

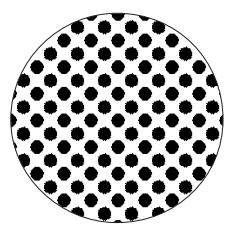

schwamm150

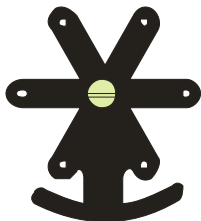

MF2-150-LV

www.aquacare-shop.de

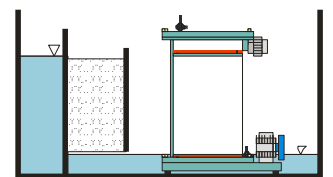
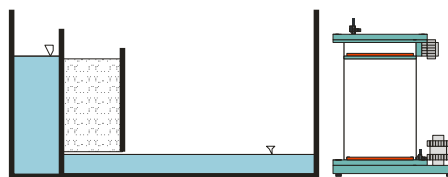
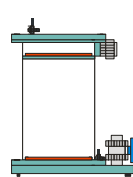
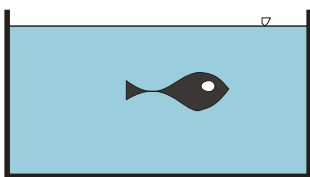

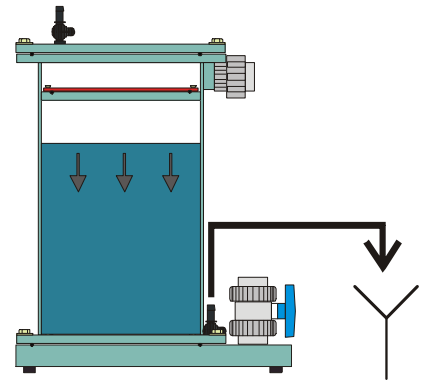
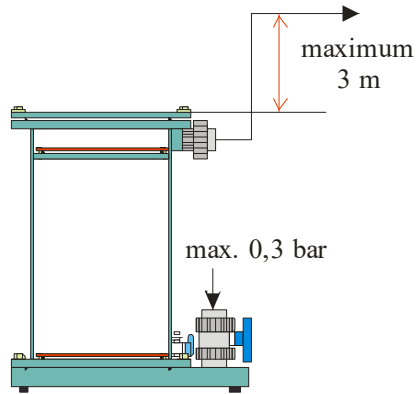

upstream





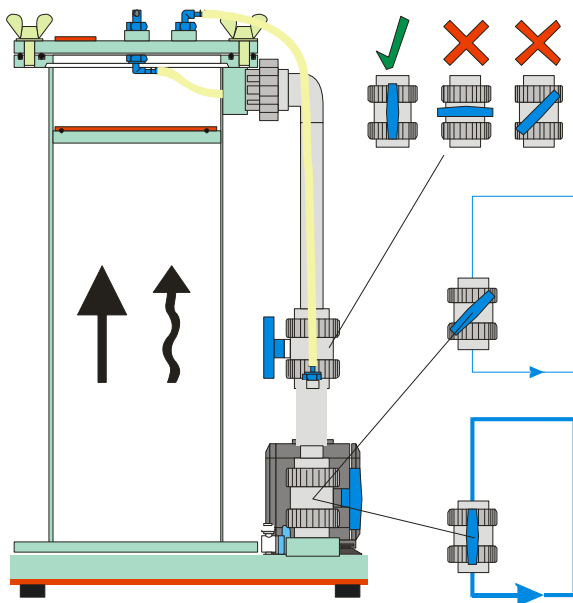
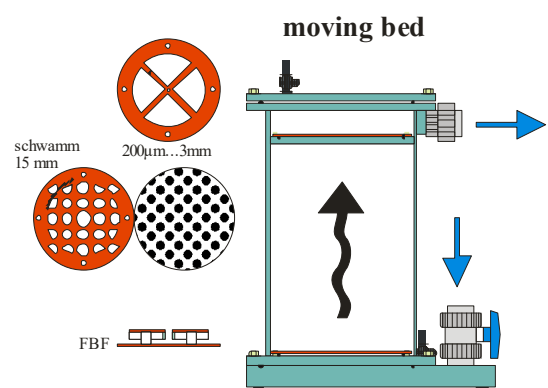
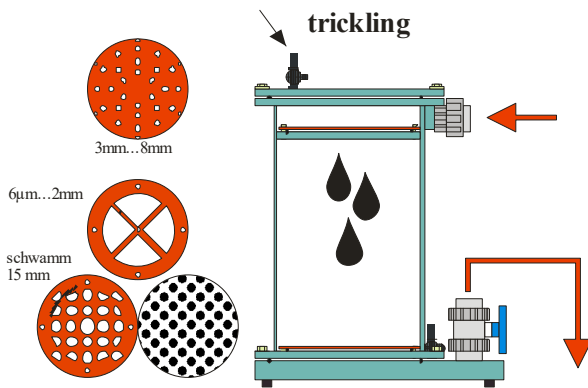
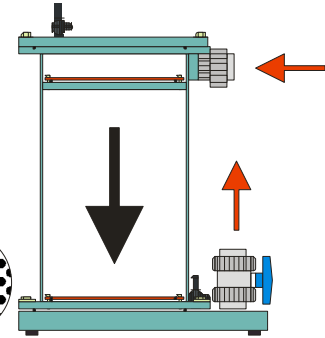
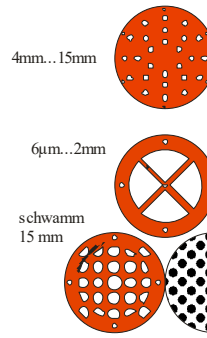
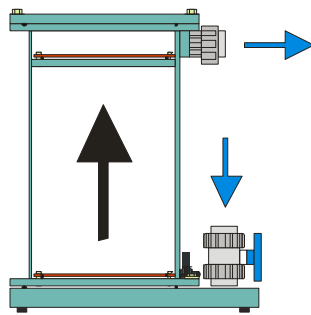
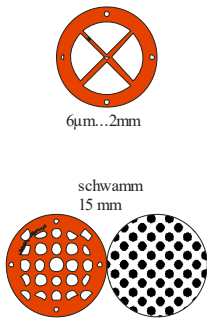



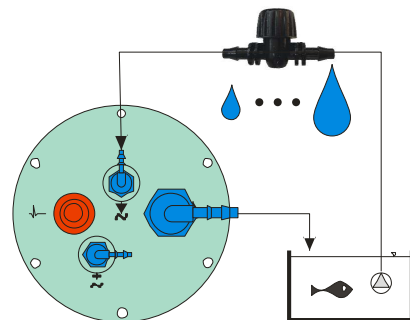





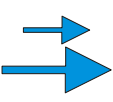















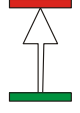























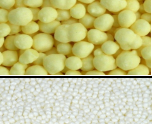





Filter

downstream



Reactor



Filtermaterial Filter Material Matériau de filtration Materiale filtrante Material filtracyjny		Up- stream	Down- stream	Moving Bed	Trickling	Flow	Time
							
	Aktivkohle Activated carbon Charbon actif Carbone attivo Węgiel aktywny					Upstream: 790 l/h downstream: 1580 l/h	15...60 d
	Zeolith Zeolite					< 800 l/h	30...360 d
	Phosphat-X-Globuli					200...300 l/h	 PO ₄
	Phosphatadsorber Phosphate adsorber Adsorbeur de phosphate Adsorbente di fosfato fosforan adsorbera					100 l/h	 PO ₄
	Quarzsand 0,8 mm Quartz sand 0.8 mm Sable de quartz 0,8 mm Sabbia di quarzo 0,8 mm Piasek kwarcowy 0,8 mm					500...900 l/h	∞
	Kalzium Calcium Calcio Wapń					< 1100 l/h	
	AquaCare +Globuli					< 160 l/h	
	Schwefel / Sulfur Soufre Zolfo Siarki					< 4 l/h	
	POC+Globuli					< 250 l/h	
	Biobälle / Bio balls Balles organiques Sfere organiche Bale organiczne					< 800 l/h	∞

Technische Daten, Technical Data, Données techniques, Dati tecnici, Dane techniczne					
DE	EN	FR	IT	PL	
Bestellnummer	Order number	Numéro de commande	Numero d'ordine	Numer zamówienia	PMMA-150
Gesamthöhe	Total height	Hauteur totale	Altezza totale	Wysokość całkowita	50/70/100 cm
Benötigte Höhe	Minimum Space	Hauteur requise	Altezza richiesta	Wysokość	+5 cm
Grundfläche	Footprint size	Empreinte de pas	Impronta	Ślad	31×22 cm
Durchmesser	Diameter	Diamètre	Diametro	Średnica	150 mm
Material	Material	Matériel	Materiale	Materiał	PMMA, NBR
Anschlüsse	Connectors	Connexions	Connessioni	Połączenia	D25
Masse	Weight	Poids	Peso	Waga	3,9, 4,2, 4,7 kg
Maximaler Zu- laufdruck	Maximum inlet pressure	pression d'entrée max- imale	pressione in ingresso massima	Maksymalne ciśnie- nie wlotowe	0,3 bar



	Aktivkohle, Activated carbon, Charbon actif, Carbone attivo, Węgiel aktywny		
 DE	http://aquacare.de/index.php/anlagenbau/anlagenbau-info/aktivkohle-einsatzgebiete.html	http://aquacare.de/index.php/en/plant-construction/plant-construction-info/activated-carbon-field-of-application.html	 EN
	Phosphat-X-Globuli, Phosphatadsorber, Phosphate adsorber, Adsorbent de phosphate, Adsorbente di fosfato, fosforan adsorbera		
 DE	http://aquacare.de/index.php/aquaristik/aquaristik-info/tipps-tricks/41-wasserchemie/221-phosphat-meerwasseraquarium.html	http://aquacare.de/index.php/en/aquaristic/aquaristic-info/hints-tricks/50-water-chemistry-physics/270-phosphate-sea-water.html	 EN
	Kalzium, Calcium, Calcio, Wapń		
 DE	http://aquacare.de/index.php/aquaristik/aquaristik-info/tipps-tricks/41-wasserchemie/217-methoden-kalkwasser.html	http://aquacare.de/index.php/en/aquaristic/aquaristic-info/hints-tricks/50-water-chemistry-physics/268-methods-lime-water.html	 EN
 DE	http://aquacare.de/index.php/aquaristik/aquaristik-info/tipps-tricks/41-wasserchemie/137-haerte-uebersicht.html	http://aquacare.de/index.php/en/aquaristic/aquaristic-info/hints-tricks/50-water-chemistry-physics/250-hardness-overview.html	 EN
 DE	http://aquacare.de/index.php/aquaristik/aquaristik-info/tipps-tricks/41-wasserchemie/138-methoden-haerte.html	http://aquacare.de/index.php/en/aquaristic/aquaristic-info/hints-tricks/50-water-chemistry-physics/254-methods-hardness.html	 EN
	Schwefel, Sulfur, Soufre, Zolfo , Siarki		
 DE	http://aquacare.de/index.php/aquaristik/aquaristik-info/tipps-tricks/41-wasserchemie/220-nitrat-kalkstufe.html	http://aquacare.de/index.php/en/aquaristic/aquaristic-info/hints-tricks/50-water-chemistry-physics/271-nitrate-filter-with-chalk-stage.html	 EN
 DE	http://aquacare.de/index.php/anlagenbau/anlagenbau-info/denitrifikation-methoden.html		
 DE	http://aquacare.de/index.php/aquaristik/aquaristik-info/tipps-tricks/41-wasserchemie/219-nitrat-muss-ein-filter-her.html	http://aquacare.de/index.php/en/aquaristic/aquaristic-info/hints-tricks/50-water-chemistry-physics/256-nitrate-filter-requirement.html	 EN



Tutorial HangOnHalter-DE



Tutorial HangOnHolder-EN



Tutorial BasisHalter-DE



Tutorial BasisHolder-EN